

## RF PIN Diodes - Dual, Common Cathode in SOT-323

### Description

Characterized by a very low reverse Capacitance the PIN Diode BAR63V-05W was designed for RF signal tuning. As a function of the forward bias current the forward resistance (rf) can be adjusted to less than  $1 \Omega$  while the low reverse capacitance offers a high isolation. Typical applications for this PIN Diodes are wireless, mobile and TV-systems.

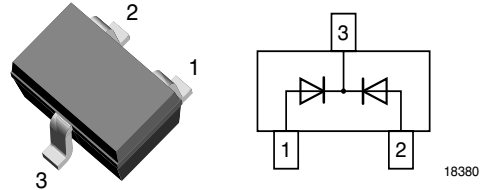

### Features

- Low forward resistance
- Very small reverse capacitance
- Lead (Pb)-free component
- Component in accordance to RoHS 2002/95/EC and WEEE 2002/96/EC



### Mechanical Data

**Case:** SOT-323 Plastic case

**Weight:** approx. 6.0 mg

#### Packaging Codes/Options:

GS18 / 10 k per 13" reel (8 mm tape), 10 k/box

GS08 / 3 k per 7" reel (8 mm tape), 15 k/box

### Applications

For frequency up to 3 GHz

RF-signal tuning

Mobile, wireless and TV-Applications

### Parts Table

Part	Ordering code	Marking	Remarks
BAR63V-05W	BAR63V-05W-GS18 or BAR63V-05W-GS08	CW5	Tape and Reel

### Absolute Maximum Ratings

$T_{amb} = 25 \text{ }^\circ\text{C}$ , unless otherwise specified

Parameter	Test condition	Symbol	Value	Unit
Reverse voltage		$V_R$	50	V
Forward current		$I_F$	100	mA
Junction temperature		$T_j$	150	$^\circ\text{C}$
Storage temperature range		$T_{stg}$	- 55 to + 150	$^\circ\text{C}$

### Electrical Characteristics

$T_{amb} = 25 \text{ }^\circ\text{C}$ , unless otherwise specified

Parameter	Test condition	Symbol	Min	Typ.	Max	Unit
Reverse voltage	$I_R = 10 \mu\text{A}$	$V_R$	50			V
Reverse current	$V_R = 35 \text{ V}$	$I_R$			10	nA
Forward voltage	$I_F = 100 \text{ mA}$	$V_F$			1.2	V
Diode capacitance	$f = 1 \text{ MHz}, V_R = 0$	$C_D$		0.28		pF
	$f = 1 \text{ MHz}, V_R = 5 \text{ V}$	$C_D$		0.23	0.3	pF

Parameter	Test condition	Symbol	Min	Typ.	Max	Unit
Forward resistance	$f = 100 \text{ MHz}, I_F = 1 \text{ mA}$	$r_f$		2.0		$\Omega$
	$f = 100 \text{ MHz}, I_F = 5 \text{ mA}$	$r_f$		1.1	2.0	$\Omega$
	$f = 100 \text{ MHz}, I_F = 10 \text{ mA}$	$r_f$		0.9		$\Omega$
Charge carrier life time	$I_F = 10 \text{ mA}, I_R = 6 \text{ mA}, i_R = 3 \text{ mA}$	$t_{rr}$		115		ns

## Typical Characteristics (Tamb = 25 °C unless otherwise specified)

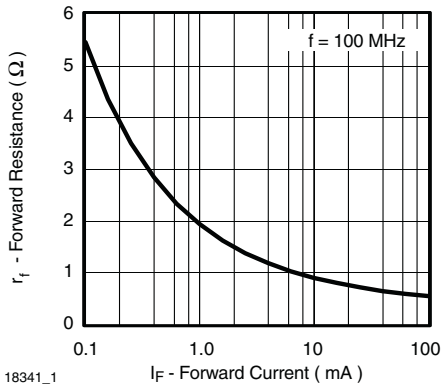

Figure 1. Forward Resistance vs. Forward Current

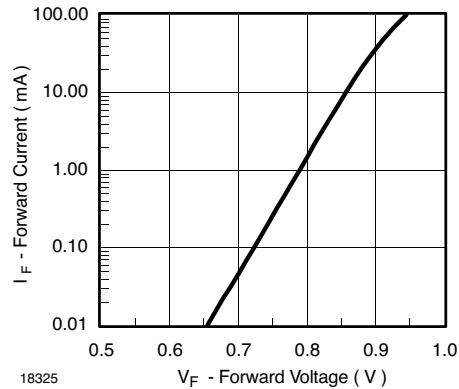

Figure 3. Forward Current vs. Forward Voltage

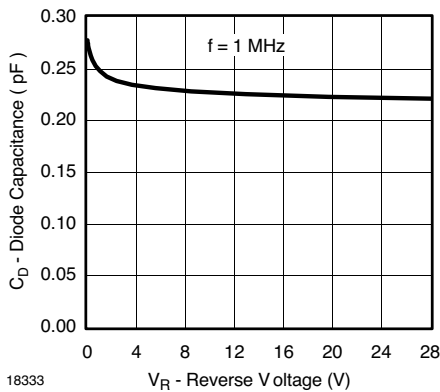

Figure 2. Diode Capacitance vs. Reverse Voltage

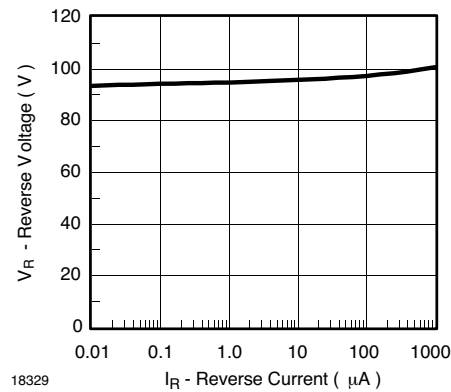

Figure 4. Reverse Voltage vs. Reverse Current

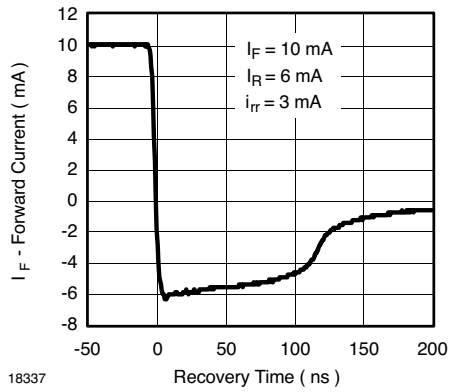
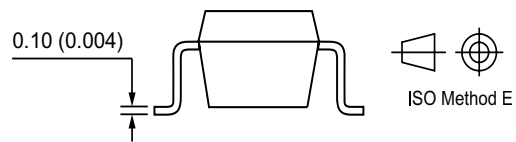
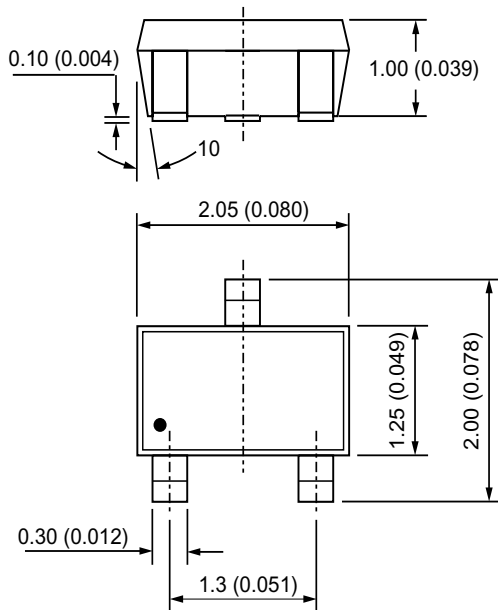
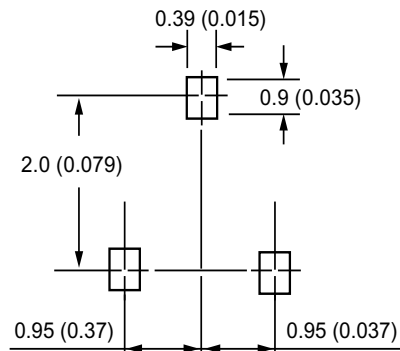

Figure 5. Typical Charge Recovery Curve

## Package Dimensions in mm (Inches)



### Mounting Pad Layout



96 12236

## Ozone Depleting Substances Policy Statement

It is the policy of Vishay Semiconductor GmbH to

1. Meet all present and future national and international statutory requirements.
2. Regularly and continuously improve the performance of our products, processes, distribution and operating systems with respect to their impact on the health and safety of our employees and the public, as well as their impact on the environment.

It is particular concern to control or eliminate releases of those substances into the atmosphere which are known as ozone depleting substances (ODSs).

The Montreal Protocol (1987) and its London Amendments (1990) intend to severely restrict the use of ODSs and forbid their use within the next ten years. Various national and international initiatives are pressing for an earlier ban on these substances.

Vishay Semiconductor GmbH has been able to use its policy of continuous improvements to eliminate the use of ODSs listed in the following documents.

1. Annex A, B and list of transitional substances of the Montreal Protocol and the London Amendments respectively
2. Class I and II ozone depleting substances in the Clean Air Act Amendments of 1990 by the Environmental Protection Agency (EPA) in the USA
3. Council Decision 88/540/EEC and 91/690/EEC Annex A, B and C (transitional substances) respectively.

Vishay Semiconductor GmbH can certify that our semiconductors are not manufactured with ozone depleting substances and do not contain such substances.

We reserve the right to make changes to improve technical design  
and may do so without further notice.

Parameters can vary in different applications. All operating parameters must be validated for each customer application by the customer. Should the buyer use Vishay Semiconductors products for any unintended or unauthorized application, the buyer shall indemnify Vishay Semiconductors against all claims, costs, damages, and expenses, arising out of, directly or indirectly, any claim of personal damage, injury or death associated with such unintended or unauthorized use.

Vishay Semiconductor GmbH, P.O.B. 3535, D-74025 Heilbronn, Germany



---

**Notice**

Specifications of the products displayed herein are subject to change without notice. Vishay Intertechnology, Inc., or anyone on its behalf, assumes no responsibility or liability for any errors or inaccuracies.

Information contained herein is intended to provide a product description only. No license, express or implied, by estoppel or otherwise, to any intellectual property rights is granted by this document. Except as provided in Vishay's terms and conditions of sale for such products, Vishay assumes no liability whatsoever, and disclaims any express or implied warranty, relating to sale and/or use of Vishay products including liability or warranties relating to fitness for a particular purpose, merchantability, or infringement of any patent, copyright, or other intellectual property right.

The products shown herein are not designed for use in medical, life-saving, or life-sustaining applications. Customers using or selling these products for use in such applications do so at their own risk and agree to fully indemnify Vishay for any damages resulting from such improper use or sale.